

Technical data



Standard enclosure

Series CT (ABS)

Type description CT-662

Article number 366000000

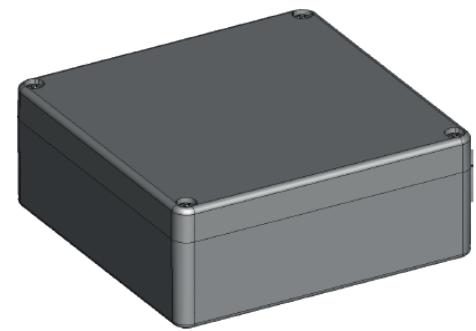
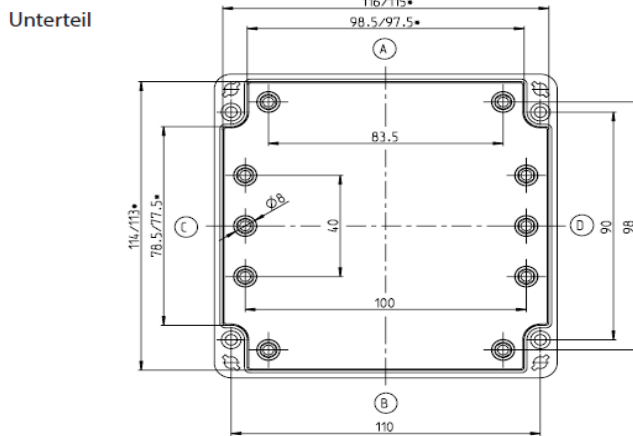
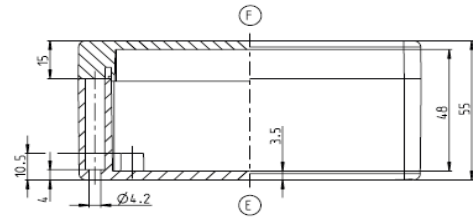
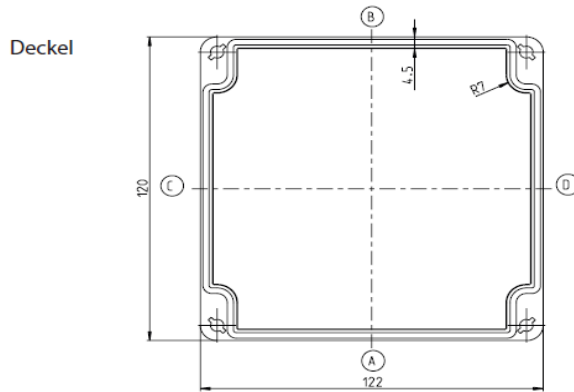

* smaller dimension in the height of the support surface of the mounting plate

CT-66

Standard version

Scope of delivery:

- Gehäuseunterteil / Lower part of enclosure / Partie inférieure du boîtier
- Gehäusedeckel / Enclosure lid / Couvercle du boîtier
- Schnellverschluss (Kombi-Kreuzschlitz) lose beigelegt / Quick fastener (combination slotted head) enclosed loose / libération rapide (à fente cruciforme combinée) fournies en vrac
- Innenliegende Befestigungsdomme für selbstformende Schrauben (Schrauben liegen bei) / Internal mounting domes for self-tapping screws (screws are included) / Dômes de montage internes pour vis autotaraudeuses (les vis sont incluses)
- RAL7035 (lichtgrau) / RAL7035 (light grey) / RAL7035 (gris clair)
- Deckeldichtung PUR / lid gasket PUR / Joint de couvercle PUR
- Einzelverpackung in Folie / Single packaging in foil / Emballage individuel sous film

Maximum possible number of threads (data for same diameter, not mixed!)

ISO M	M12	M16	M20	M25	M32	M40	M50	M63
Side A/B	9	4	3	2	0	0	0	0
Side C/D	4	3	2	0	0	0	0	0

BERNSTEIN AG . Hans-Bernstein-Straße 1 . 32457 Porta Westfalica . www.bernstein.eu

Technical changes and errors excepted.

This data sheet corresponds to the technical status as of 17.05.2023 [TT.MM.JJJJ] and will not be withdrawn in the event of changes.

Technical data



Standard enclosure
Series CT (ABS)

Properties table CT-662 Article number 366000000

Specification	Value	according to standard	Comment
General data			
Weight	218g		
External dimensions	122x120x55		
Degree of protection			
<i>IP code</i>	IP66	DIN EN 60529	
<i>IP code</i>	—	DIN EN 60529	
<i>IK code</i>	IK07	DIN EN 62262	
Materials			
<i>Enclosure</i>	ABS	—	ABS light grey
<i>Lid fastener</i>	1.4303	DIN EN 10088-3	Quick release fastener
<i>Additional screws</i>	ST verzinkt	—	Panhead tapping screws
<i>Spring washer</i>	—	—	—
<i>Press-in nut</i>	—	—	—
<i>Seal</i>	PUR	—	Colour: black-grey 2K-polyurethane foam gasket
Toxic behaviour	Halogenfrei / Halogen-free / Sans halogène		—
Mechanical properties			
Torques			
<i>Cover fastener</i>	—		1/4 Rotation
<i>Ground screw</i>	—		—
<i>Fastening accessories</i>	1,0 Nm		e.g. support rail, mounting plate
<i>Other fastening</i>	1,0 Nm		Screw channel, external fixing bracket
Maximum installation weight	0,5Kg		—
Thermal properties			
Temperature range			
<i>Enclosure complete</i>	-40°C bis +80°C	—	—
<i>Enclosure material</i>	-40°C bis +80°C	—	—
<i>Seal</i>	-40°C bis +100°C	—	PUR
Fire behaviour			
<i>Flammability</i>	Flammklasse: 1,2mm = HB75 Flammklasse: 1,5mm = HB75 Flammklasse: 3,0mm = HB40	UL 94	Same content as IEC60659-11-10 and IEC 60695-11-20
<i>Glow wire test</i>	—	—	—
Temperature index Enclosure material			
<i>RTI (tensile strength)</i>	60°C	UL 746 B	—
<i>RTI (impact strength)</i>	60°C	UL 746 B	—
<i>RTI (dielectric strength)</i>	60°C	UL 746 B	—
Heat resistance			
<i>Insulation class</i>	—	—	—
Fire behaviour - Fire protection in railway vehicles according to EN 45545-2:2020-10			
<i>Requirement set R1</i>	—	—	—
<i>Requirement set R6</i>	—	—	—
<i>Requirement set R7</i>	—	—	—
Oxygen index	—	—	—
Storage temperature	-20°C bis +60°C	—	—
Thermal resistance	6,09 K/W	—	taking into account the effective power loss

BERNSTEIN AG . Hans-Bernstein-Straße 1 . 32457 Porta Westfalica . www.bernstein.eu

Technical changes and errors excepted.



This data sheet corresponds to the technical status as of 17.05.2023 [TT.MM.JJJJ] and will not be withdrawn in the event of changes.

Technical data



Standard enclosure
Series CT (ABS)

Properties table CT-662 Article number **366000000**

Specification	Value	according to standard	Comment
Usual operating conditions according to DIN EN 62208			
Ambient temperature			
<i>Indoor installation</i>	-5°C bis +40°C	—	on average over 24h +35°C
<i>Outdoor installation</i>	-25°C bis +40°C	—	on average over 24h +35°C
Relative humidity			
<i>Indoor installation</i>	max. 50% bei +40°C	—	at low temperatures also higher (e.g. 90% at 20°C); occasionally condensation permissible
<i>Outdoor installation</i>	zeitweise / temporary / temporairement 100 % bei +25°C	—	at low temperatures also higher (e.g. 90% at 20°C); occasionally condensation permissible
Chemical properties			
Corrosion resistance	—	—	—
Corrosion resistance	—	—	—
Salt spray test	—	—	—
Resistance list for enclosure materials and seals			see catalogue details
Electrical properties			
Protection class	II	EN 61140 / VDE 0140-1	 Protection through double or reinforced insulation
Rated voltage	max. 1000V	—	—
Surface resistance	10 ¹³ Ohm	IEC 60093	—
Dielectric strength	17 kV/mm	IEC 60243-1	—
Further specifications			
General tolerances			
<i>Casting tolerance</i>	TG 4	DIN ISO 20457	Plastics moulded parts – Tolerances and acceptance conditions
<i>Machining tolerance</i>	mH	DIN ISO 2768	Machining tolerance
Product standard	konform/compliant/conforme	DIN EN 62208	Empty enclosures for low-voltage switchgear and controlgear assemblies
Approval			
<i>c UL us</i>	—	—	—
<i>ATEX / IECeX</i>	 —  —	—	—
<i>DNV</i>	—	—	—
Conformities / Directives			
<i>Directive 2011/65/EU (RoHs)</i>	konform/compliant/conforme	2011/65/EU (RoHs)	RoHs
<i>Low Voltage Directive</i>	konform/compliant/conforme	2014/35/EU	—
<i>Electrical Equipment (safety) Regulations 2016 (CA UK)</i>	konform/compliant/conforme	2016 NO.1101	—

BERNSTEIN AG . Hans-Bernstein-Straße 1 . 32457 Porta Westfalica . www.bernstein.eu

Technical changes and errors excepted.

This data sheet corresponds to the technical status as of 17.05.2023 [TT.MM.JJJJ] and will not be withdrawn in the event of changes.